

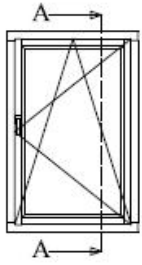

SOFTLINE 88

Skala 1:2



A - A

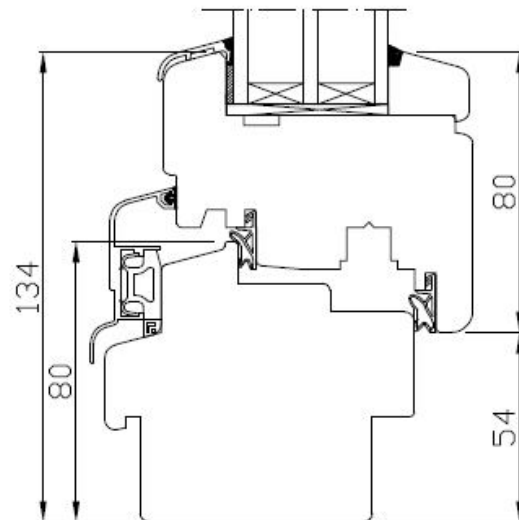
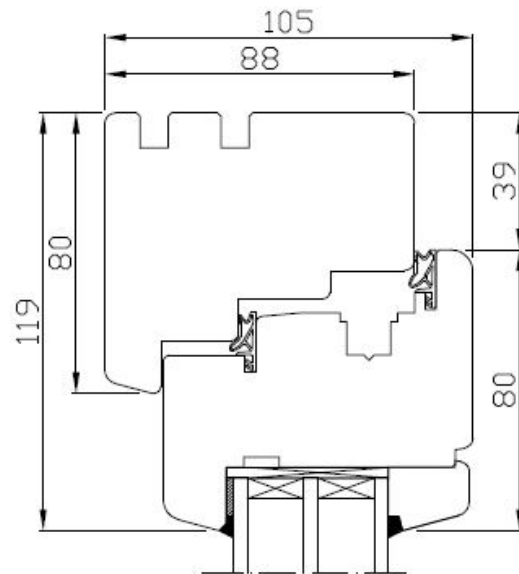



SOFTLINE 88

Skala 1:2

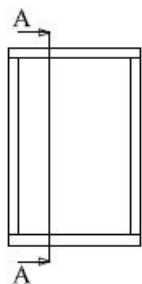

A - A

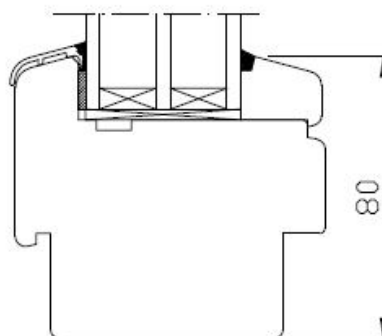
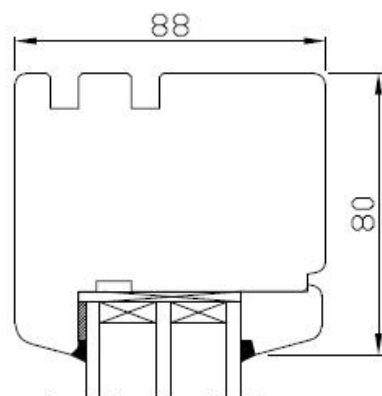



SOFTLINE 88

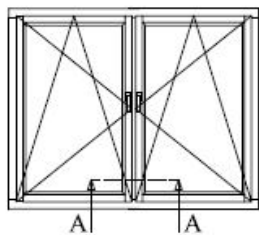

A - A

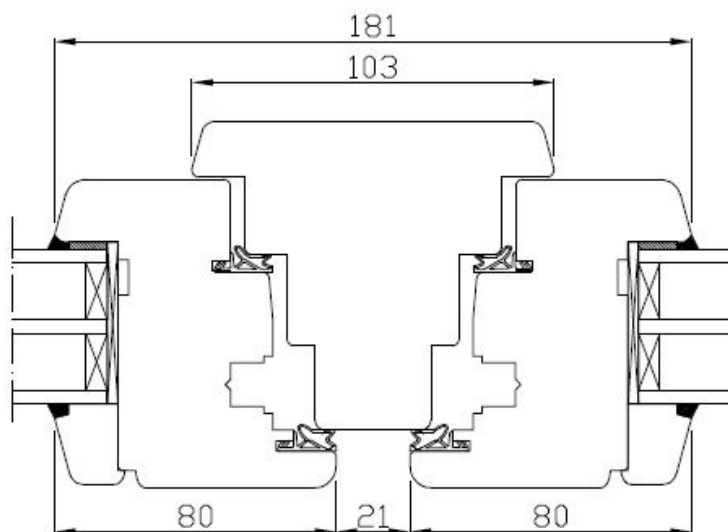



SOFTLINE 88

Skala 1:2

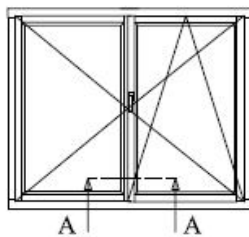

A - A

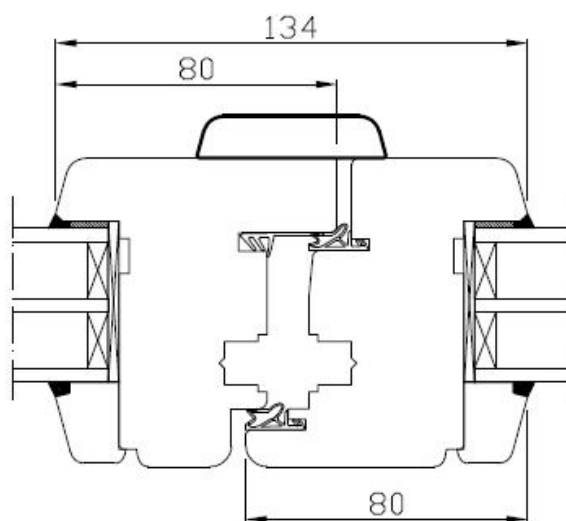



SOFTLINE 88

Skala 1:2

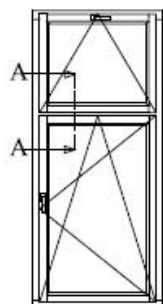

A - A

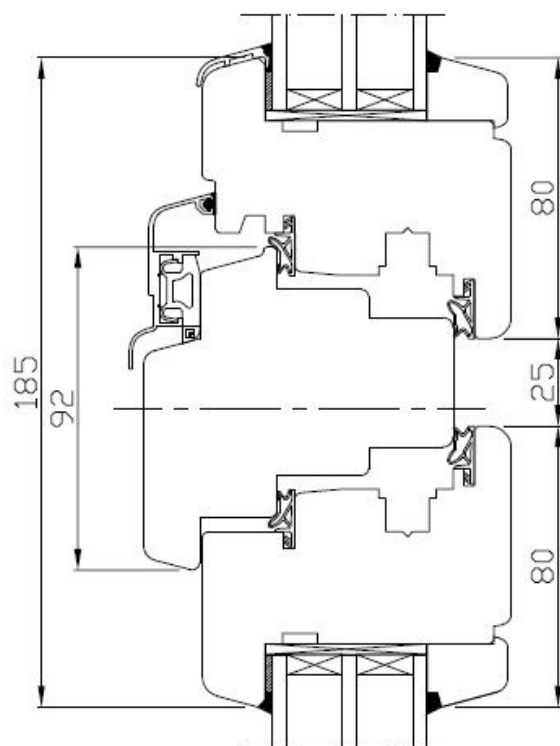



SOFTLINE 88

Skala 1:2

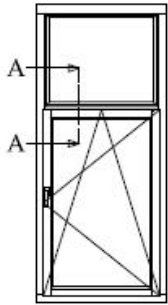

A - A

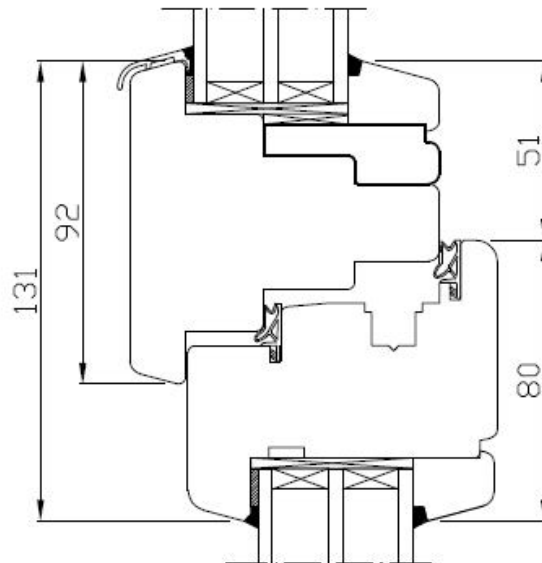



SOFTLINE 88

Skala 1:2

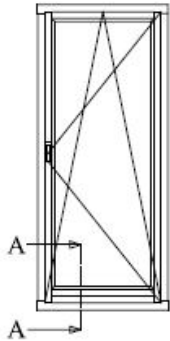

A - A

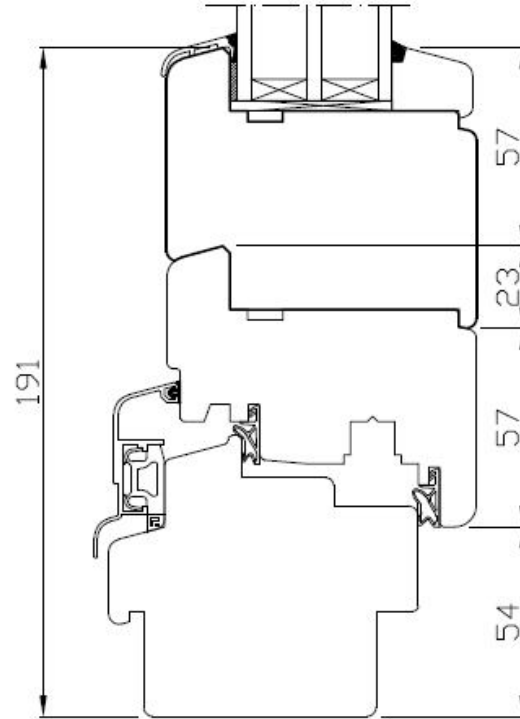

A' - A'

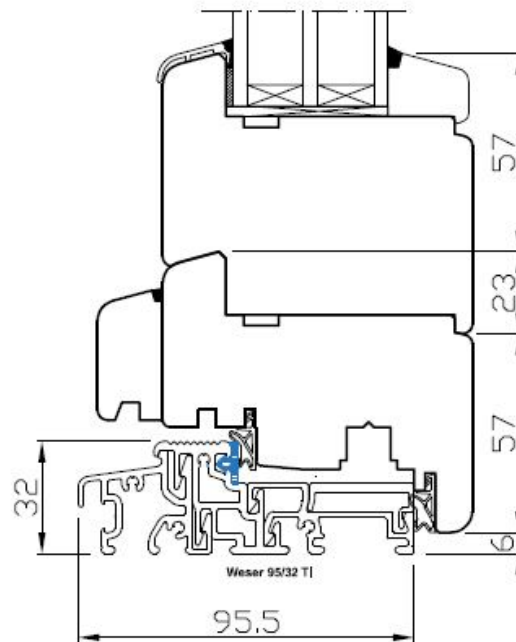



SOFTLINE 88

Skala 1:2

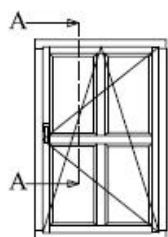

A - A

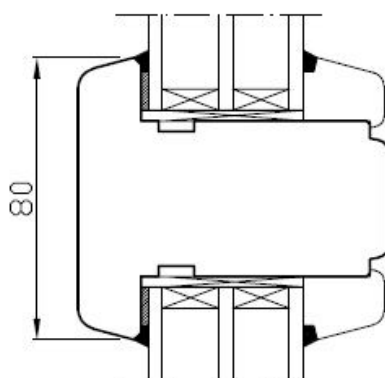





SOFTLINE 88

Skala 1:2

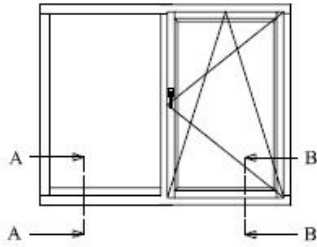

A - A

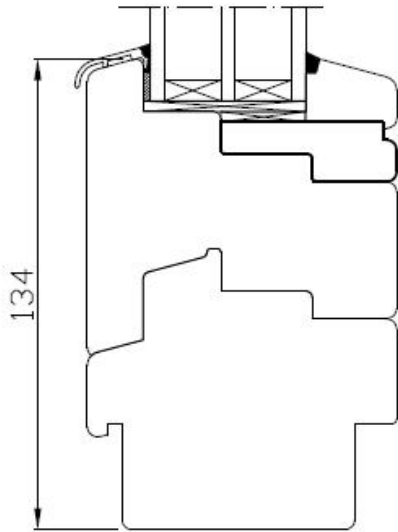

B - B

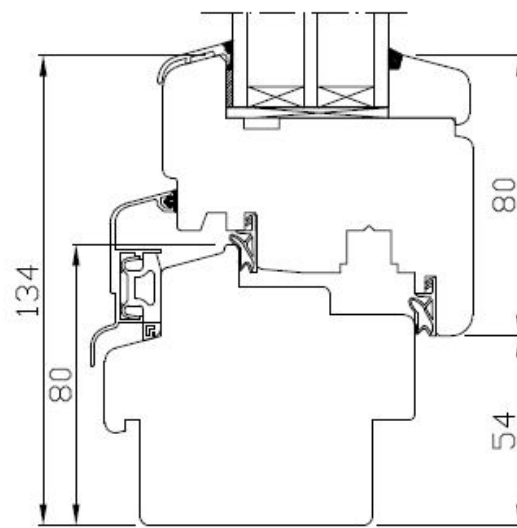



SOFTLINE 88

Skala 1:2

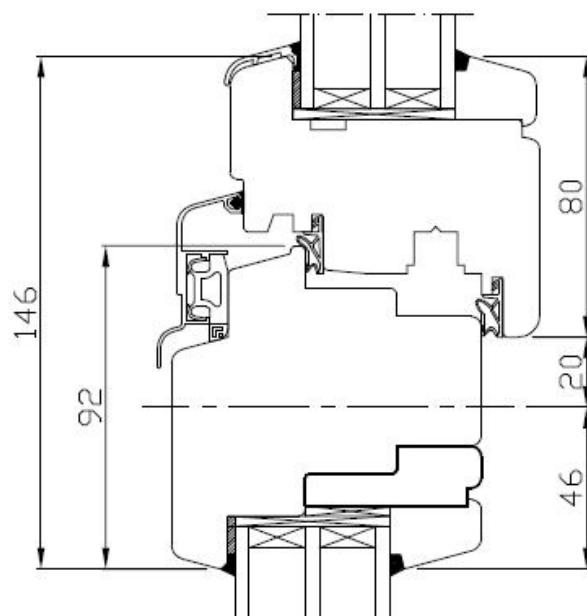
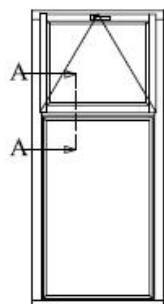



SOFTLINE 88

Skala 1:2

